

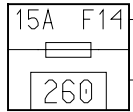

D4F712/DG/BVM5

X76

03



NO
A14 — AP3—JA

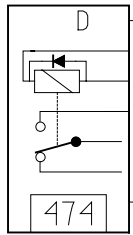

NO
D1 — AP3—JA

D3 — AP3—JA

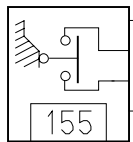

1 — AP3—JA

2 — H66P—MA

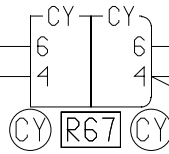

6 — H66P—SA

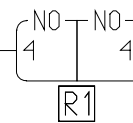

NO — H62—VI

NO — M—NO

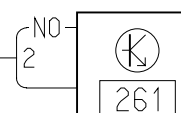
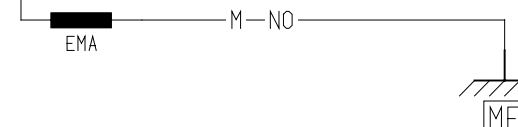
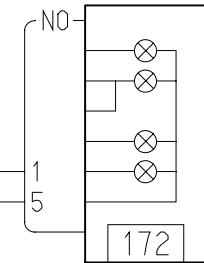

H66P—MA

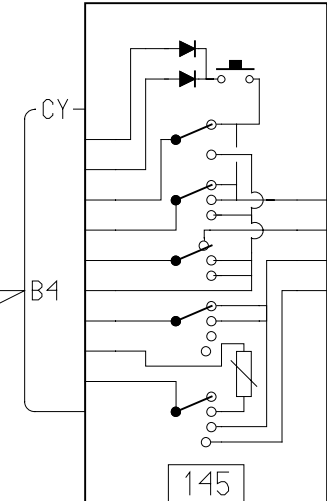

CY
B4

145

3-111