

X10
14

DG/SDPCLV

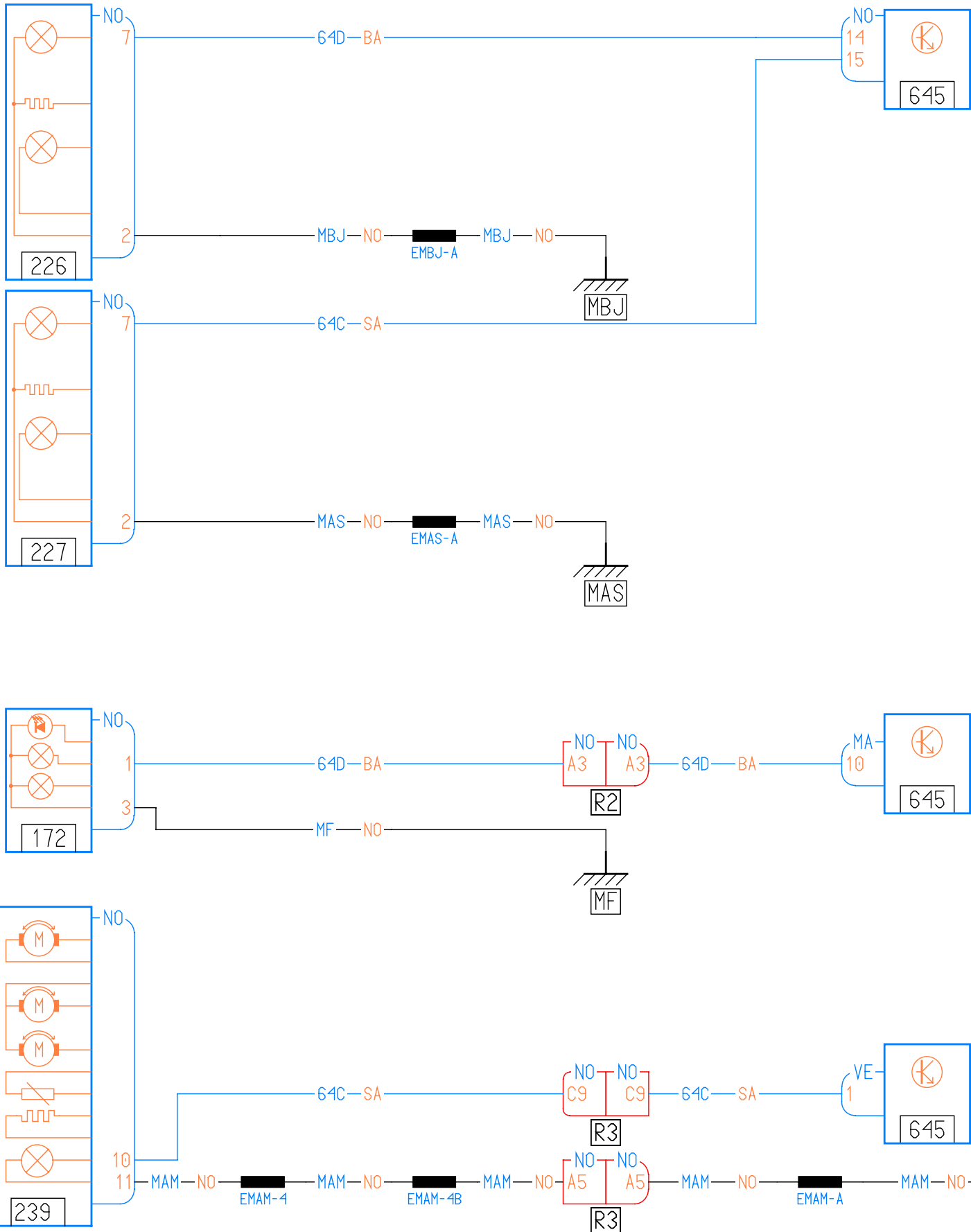

3-77

1519

1519

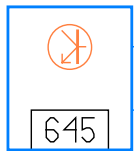

VE 21 64D-BA

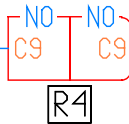

NO NO C9 C9 R4

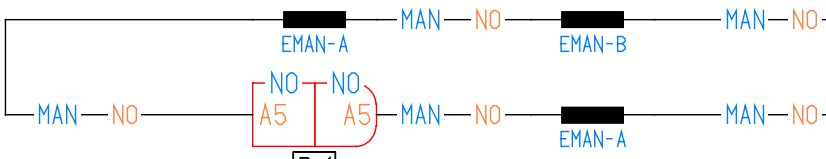
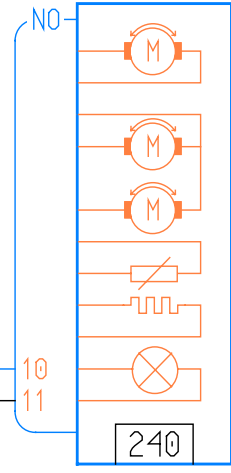

NO NO A5 A5 R4

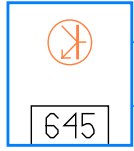

GR 30 64F-SA

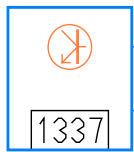

MA 11 LPD-BE

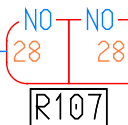

NO NO 28 28 R107

LPD-BE ELPD-B

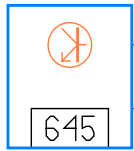

GR 20 64Q-VE

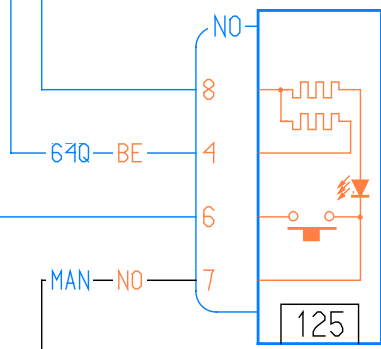

64Q-BE

MAN-NO

1519

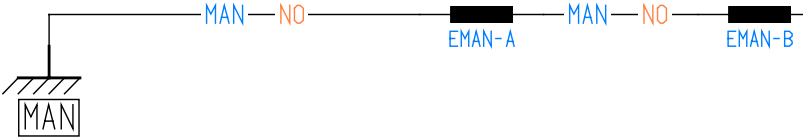

EMAN-A

EMAN-B

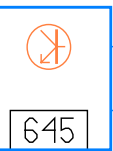

MA 11 64C-SA

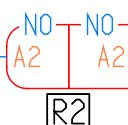

NO NO A2 A2 R2

64C-SA

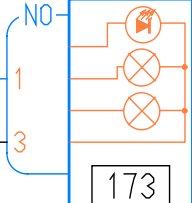

1519



EMG-A

MG-NO

1519

