

X10
14

DD/LVAREL

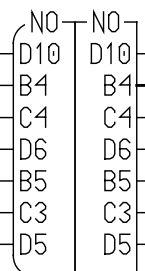

R3

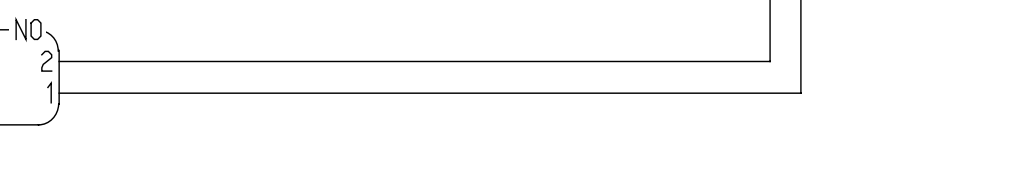
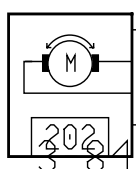
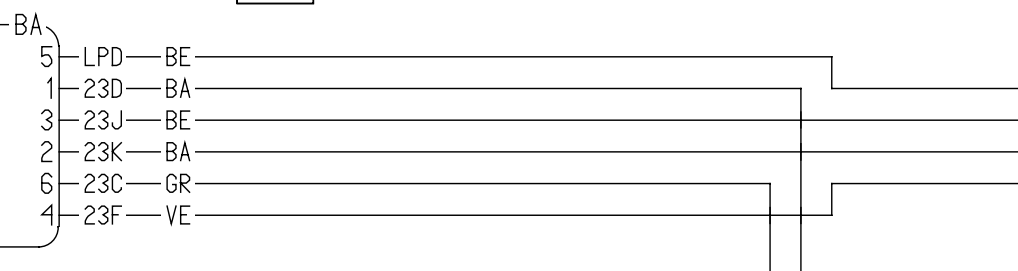
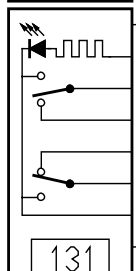
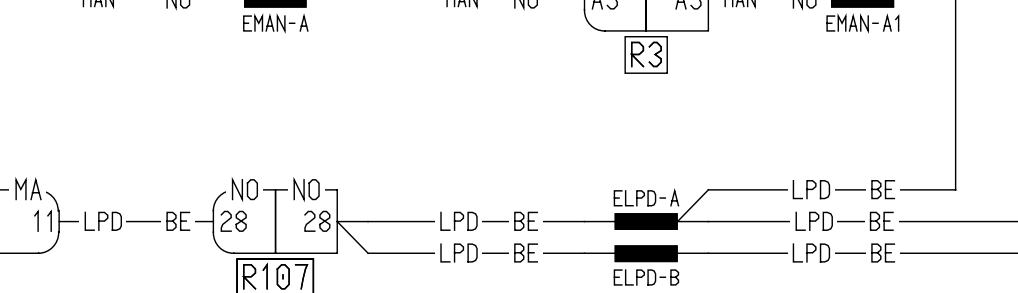
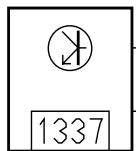
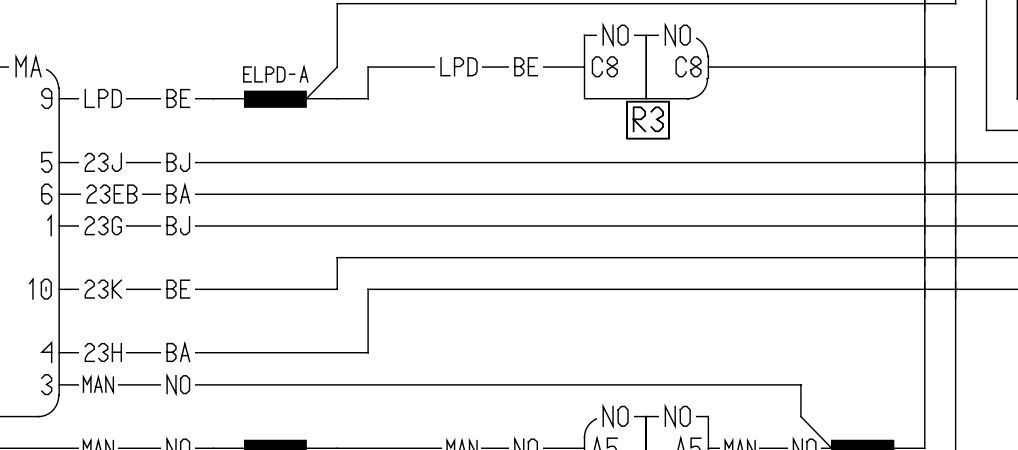
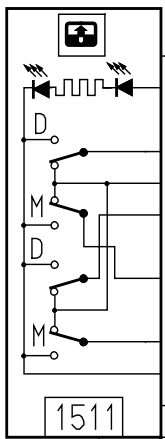
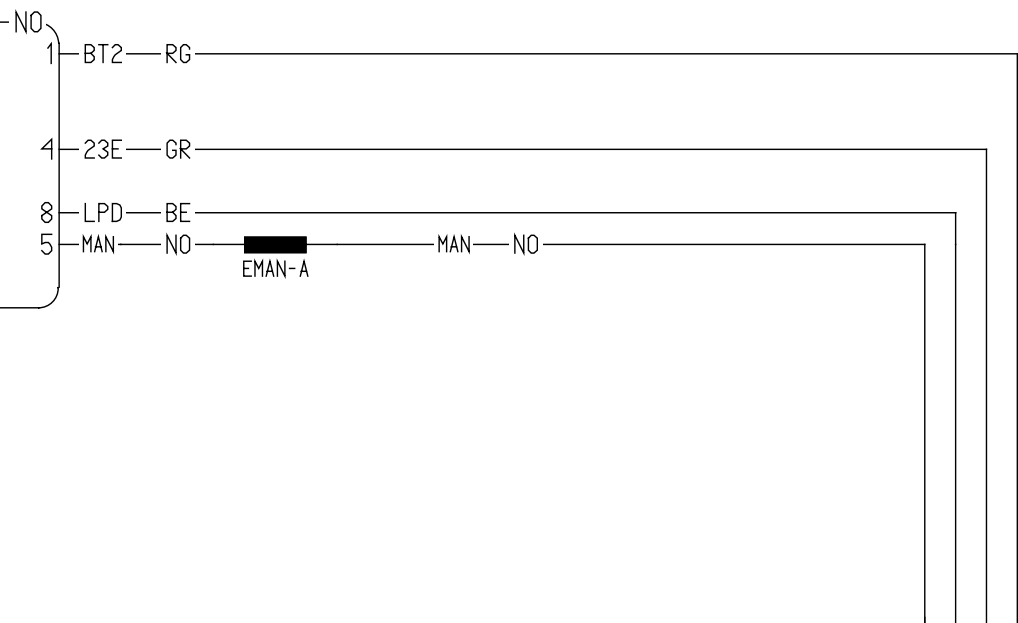
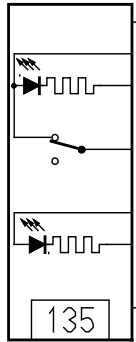
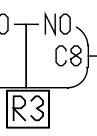

R3

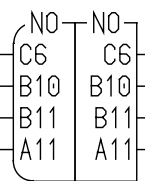

R219



R107

